

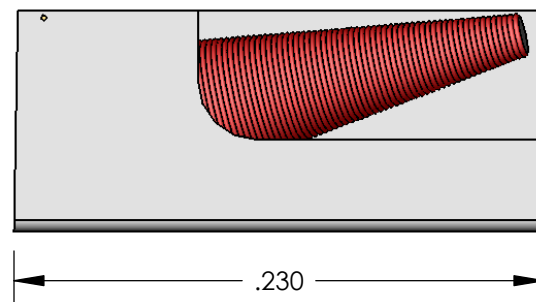

PICONICS

CC82T44K240G5-C

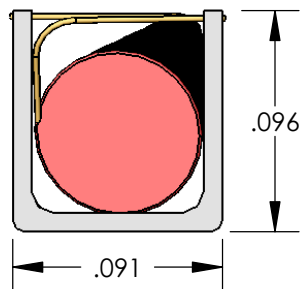
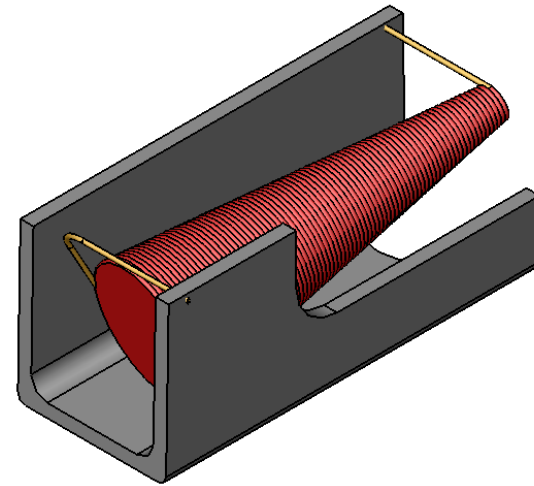
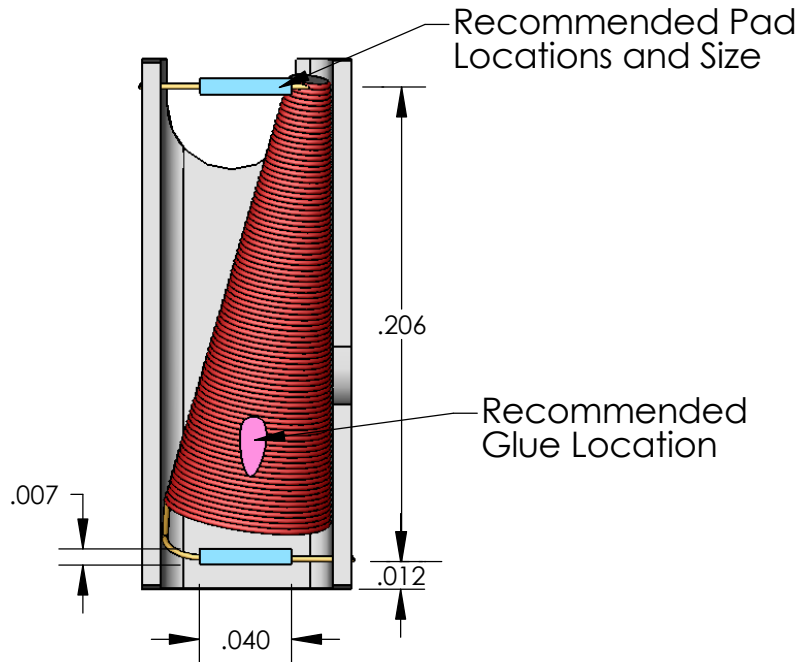

Electrical

Frequency:	10 MHz-15 GHz
Return Loss:	-26dB typ. In/Out
Insertion Loss:	-.35dB typ.
Q Typ. @ 10 MHz:	25-30
I _{dc} (max):	180 mA
L @ 10 MHz:	6.70 μH
Fill:	Powdered Iron (S class)
Leads:	5-10uin Gold Plated
DCR Typ:	2.83 ohms